



# INSTRUCTIONS

# AQUALIGHT PLUS™/PRO™

CORALIFE®

**IMPORTANT SAFETY NOTE:** Make sure to unplug all fixture power cords and ballast power cords before adjusting fixture position over aquarium or replacing any parts on the fixture.

## PARTS LIST

(2) J-Hook Wood Screw

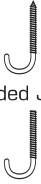

(2) Butterfly Clip



(2) Hanging Bracket

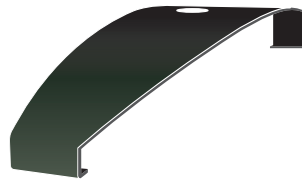

(2) Ceiling Mount Bracket



(2) Threaded J-Hook for Butterfly Clip



(2) Suspension Wire

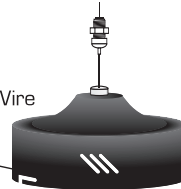

(4) Wood Screw





## INSTALLATION

**1.** Mount J-Hook Screw into the ceiling. See 1 A and 1 B for J-Hook installation.

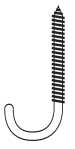
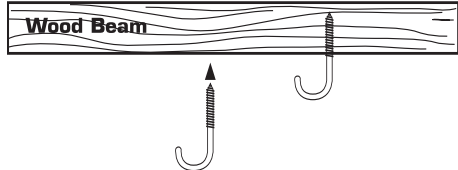
**1 A.** Wood Beam Installation

<p><b>Hardware:</b></p>  <p>J-Hook Wood screw</p>	<ol style="list-style-type: none"> <li>1. Locate wood beam in ceiling.</li> <li>2. Drill a small pilot hole in intended location for J-hook wood screw.</li> <li>3. Twist J-hook into wood.</li> </ol> 
--	---

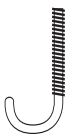
**1 B.** Drywall Installation

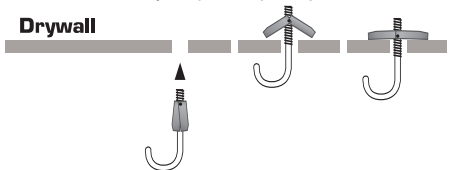
<p><b>Hardware:</b></p>  <p>Threaded J-Hook for Butterfly Clip</p>  <p>Butterfly Clip</p>	<ol style="list-style-type: none"> <li>1. Drill a hole in the drywall large enough to insert butterfly clip with J-hook.</li> <li>2. Screw butterfly clip onto J-hook.</li> <li>3. Insert J-hook screw with butterfly clip inside the drywall making sure that the butterfly clip snaps open.</li> </ol> <p><b>Drywall</b></p>  <p>Note: Ceiling must be in good condition. Do not mount if the ceiling contains water damage or cracks.</p>
---	--

**2.** Attach Suspension Wire to the Hanging Bracket.

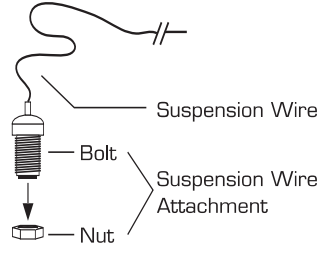
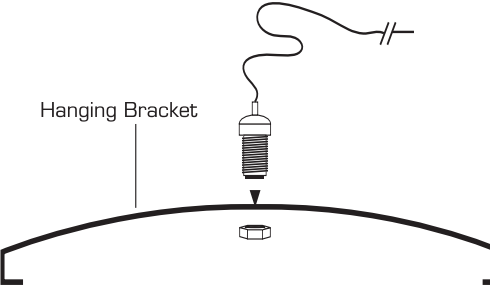
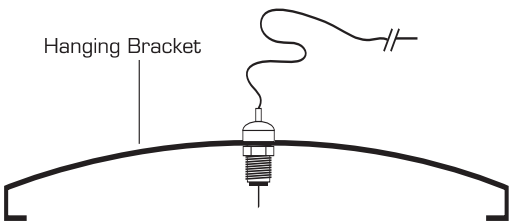
<ol style="list-style-type: none"> <li>1. Unscrew Suspension Wire Attachment nut.</li> </ol>  <p>Suspension Wire</p> <p>Bolt</p> <p>Suspension Wire Attachment</p> <p>Nut</p>	<ol style="list-style-type: none"> <li>2. Insert Suspension Wire Attachment into the Hanging Bracket.</li> </ol>  <p>Hanging Bracket</p>	<ol style="list-style-type: none"> <li>3. Screw Suspension Wire Attachment nut back onto Suspension Wire bolt and tighten.</li> </ol>  <p>Hanging Bracket</p>
--	---	---

**2A.** Adjust Suspension Wire Attachment to allow 1/2" of Suspension Wire slack.

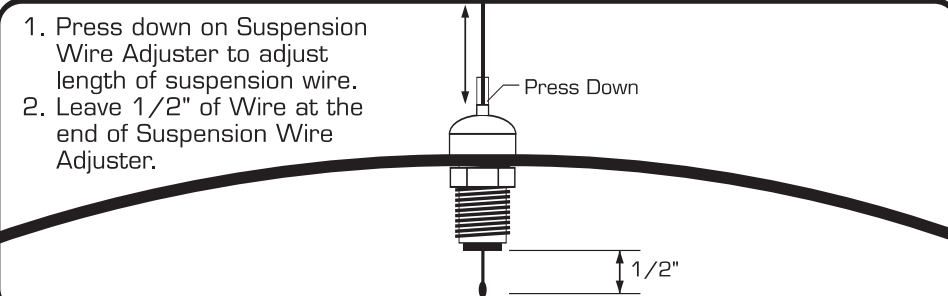
<ol style="list-style-type: none"> <li>1. Press down on Suspension Wire Adjuster to adjust length of suspension wire.</li> <li>2. Leave 1/2" of Wire at the end of Suspension Wire Adjuster.</li> </ol>	 <p>Press Down</p> <p>1/2"</p>
---	--



CORALIFE®

**IMPORTANT SAFETY NOTE:** Make sure to unplug all fixture power cords and ballast power cords before adjusting fixture position over aquarium or replacing any parts on the fixture.

### 3. Attach Hanging Bracket to the fixture. See 3A for Aqualight Plus and 3B for Aqualight Pro.

#### 3A. Aqualight Plus Installation

1. Make sure to turn off power switches and unplug the ballast from power outlet.
2. Place unit on a non-abrasive flat surface.
3. Using a Phillips screw driver, unscrew the right side end plate.

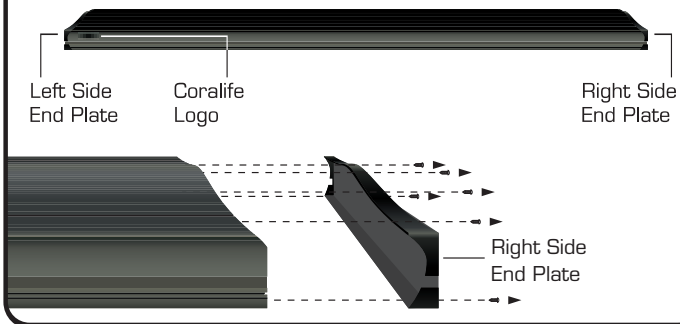

4. Insert Hanging Brackets onto Top Track of the fixture and slide the brackets 3 inches from each end of the fixture.
5. Replace Right Side End Plate and tighten screws.

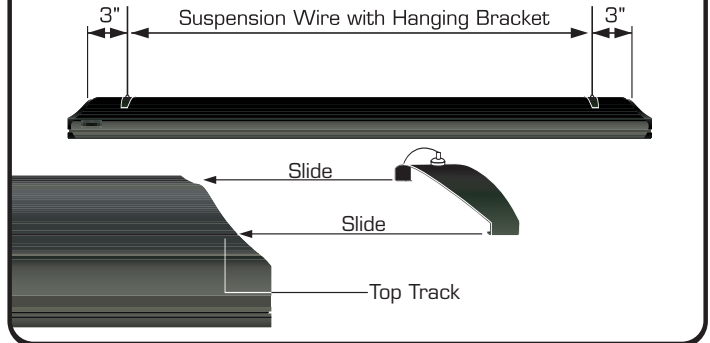

#### 3B. Aqualight Pro Installation

1. Insert Hanging Brackets onto Top Track of the fixture and slide the brackets 3 inches from each end of the fixture.
2. Slide brackets 3 inches from each end of the fixture.

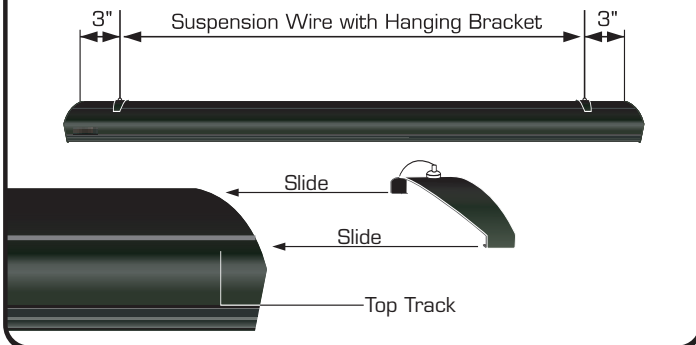

#### 4. Attach Suspension Mount Bracket

1. Insert Ceiling Mount Bracket through J-Hook.
2. Using a Phillips screw driver, attach the Ceiling Mount Bracket onto ceiling with 2 wood screws.

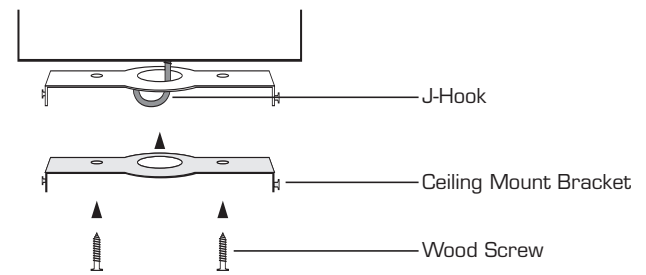

#### 5. Hang unit and adjust Suspension Wire

1. Using a Phillips screw driver, loosen Suspension Wire Fastener and adjust Suspension Wire.
2. Measure length of Suspension Wire so that it hangs 3"-6" above the aquarium and **tighten screws**.

**Note:** The Suspension Wire Fastener must be screwed in tight before hanging the light fixture.

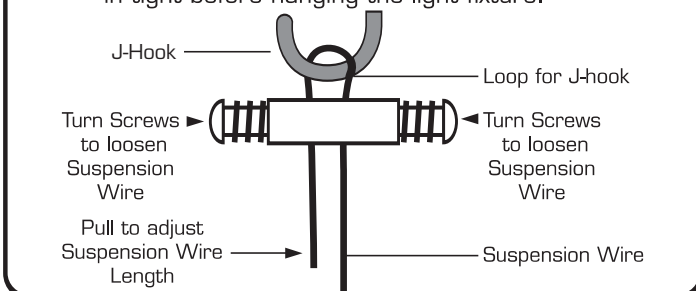

#### 6. Attach Suspension Wire Cover

1. Align and attach Ceiling Mount Bracket side-screws with Suspension Wire Cover slots.
2. Twist Suspension Wire Cover until side-screw locks in place.

