

## OWNER'S MANUAL

# ARCTICA®

## TITANIUM CHILLER

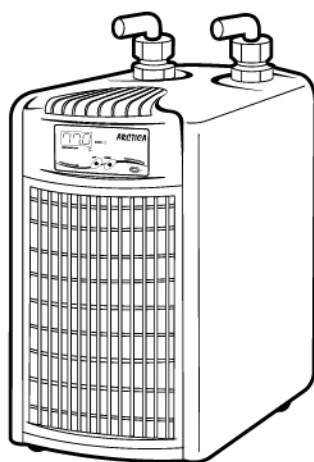

### SPECIFICATIONS

**ARCTICA®** – TITANIUM CHILLER

Model: DBA-075

Power Supply: 115Volt

1/10HP / In-Line

IC Electronic Temperature Controller

Ozone Friendly Refrigerant (R-134a)

Distributed by : **TRANSWORLD AQUATIC ENTERPRISES, INC.**

TEL: (310)672-0480      FAX: (310)672-7261

**www.jbjlighting.com**

# TABLE OF CONTENTS

<b>1. SAFETY</b>		1
1-1. Safety Instructions		2
1-2. Data Label		2
<b>2. INTRODUCTION</b>		3
<b>3. RECEIVING AND INSPECTION</b>		3
<b>4. INSTALLATION</b>		4
4-1. Installation to Aquarium (or Tank)		4
4-2. How to Connect Hose		4
<b>5. INSTRUCTION FOR USE</b>		5
5-1. Start Up		5
<b>6. MAINTENANCE</b>		6
6-1. Operations To Be Carried Out Every 6 Months		6
Table 1	Cooler Specifications	6
Figure 1	Electrical Diagram	7
Figure 2	Part Name for Cooler	8
Figure 3	Exploded View and Part List	9



## 1. SAFETY

The coolers are designed and built with safety as a prime consideration; industry-accepted safety factors have been used in the design. Each cooler is checked at the factory for safety and operation. All necessary adjustments are made before shipment.

Follow the maintenance schedules outlined in this manual for good performance and safe operation. Maintenance should be done only by qualified personnel with proper tools.

Carefully read the following safety rules before proceeding with installation, operation or maintenance. The rules are essential to ensure safe cooler operation. Failure to follow these rules void the warranty or results in cooler damage or personal injury.

1. Do not install or try to repair a cooler that has been damaged in shipment. See RECEIVING AND INSPECTION for instructions.
2. Electricity has the potential to cause personal injury or equipment damage. Before doing any work on the cooler, be sure the electrical supply has been locked.
3. Do not operate the cooler at temperature above the maximum conditions(See Table 1).
4. Always supply electrical power that complies with the voltage shown on the data label.
5. Work on the refrigeration system must be done only by a competent refrigeration mechanic.
6. Use only manufacturer's genuine replacement parts. The manufacturer bears no responsibility for hazards caused by the use of unauthorized parts.

---

## 1-1. Safety Instructions

Safety instructions in this manual are boldfaced for emphasis. The signal words **DANGER**, **WARNING** and **CAUTION** are used to indicate hazard seriousness levels as follows:



**DANGER** - Immediate hazard which **WILL** result in severe injury or death.



**WARNING** - Hazard or unsafe practice which **COULD** result in severe injury or death.

## 1-2. Data Label

The cooler data label contains identification information. If the data label is missing or damaged, contact your local distributor and request a replacement.

<b>ARCTICA®</b> <small>www.jbjlighting.com</small>	
<b>Model</b>	<b>DBA-075</b>
<b>Power Supply</b>	<b>115V 1PH 60Hz</b>
<b>Compressor</b>	<b>1/10HP</b>
<b>Refrigerant</b>	<b>R-134a</b>
<b>Heat Exchanger</b>	<b>Titanium Heat Exchanger</b>
<b>Serial No.</b>	
<small>Distributed by : TRANSWORLD AQUATIC ENTERPRISES, INC. TEL : (310) 672-0480 FAX : (310) 672-7261</small>	

---

## **2. INTRODUCTION**

Aquarium Fish Coolers use mechanical refrigeration to cool water in the aquarium. See Table1 for rated capacity and other cooler specifications.

Throughout this manual, the word "cooler" is used to refer to Aquarium Fish Coolers. To ensure continuing good performance and safe operation, everyone who installs, uses or maintains the cooler must read and carefully follow the instruction in this manual.

---

## **3. RECEIVING AND INSPECTION**

Inspect the cooler closely when it is received. Record any indication of damage on the delivery receipt, especially if the cooler will not be immediately uncrated. Obtain the delivery person's signed agreement to recorded damages to facilitate future insurance claims.

Since the cooler is shipped F.O.B. Factory, the manufacturer's responsibility for the shipment ceases when the carrier signs the bill of lading.

If goods are received short or damaged condition, notify the carrier and insist on a notation of the loss or damage across the face of the freight bill. Otherwise no claim can be enforced against the carrier.

If concealed loss or damage is discovered, notify your carrier at once and request an inspection. This is absolutely necessary. Unless you do this, the carrier will not consider any claim for loss or damage. The carrier will make an inspection and may grant a concealed damage notation. If you give the carrier a clear receipt for the goods that have been damaged or lost in transit, you do so at your own risk and expense.

The manufacturer is willing to assist you in collecting claims for loss or damage. Willingness does not make the manufacturer responsible for collecting claims or replacing material. Claim filing and processing is your responsibility.

## 4. INSTALLATION

Place the cooler in a ventilated place and away from sources of heat, taking care that the evacuation holes, indispensable for taking in air, are not less than 1 ft from any obstacle.

### 4.1 Installation to Aquarium (or Tank)

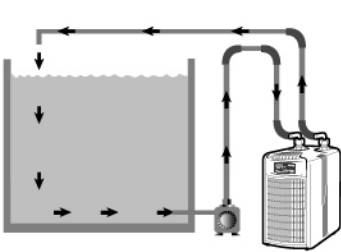

1. Connection of outside circulation pump

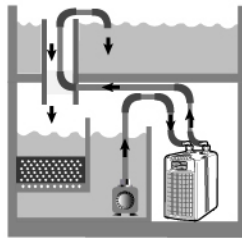

2. Connection of circulation pump in the filter

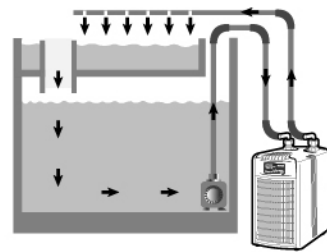

3. Connection of inside circulation pump

### 4.2 How to Connect Hose

#### 1. Method of connecting hose to cooler

1. Unscrew hose nut and remove rubber gasket.
2. Insert hose elbow into hose net.
3. Insert hose elbow into rubber gasket.
4. Screw onto cooler and hand tighten.
5. Connect rubber tubing over threaded portion of hose elbow.
6. Fasten hose clamp to secure hold.

#### 2. Checking equipment connection

Hose Elbow – Large	3/4"
Medium	5/8"
Small	1/2"

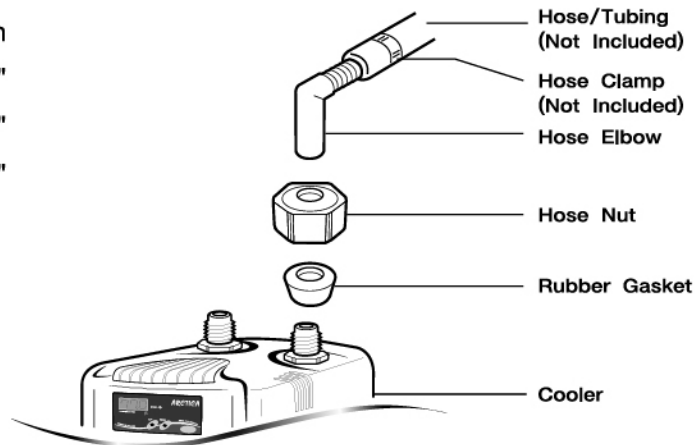
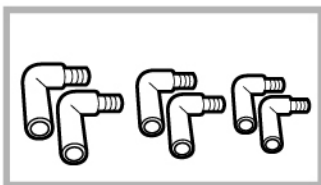

## 5. INSTALLATIONS FOR USE

### 5.1 Start Up

- 1) Once all connections are made, circulate water through chiller before turning on the unit.
- 2) Check all connections for leaks.
- 3) Verify electricity rating, and then plug power cord into a dedicated electrical outlet.
- 4) This unit has been factory-set at 77°F.
- 5) The Digital Display will read the current water temperature.
- 6) The light indicator will begin to blink.
- 7) Chiller will automatically turn on within 3 minutes.
- 8) Your chiller has now been activated.

\* This unit contains an Auto Digital Temperature Control System. This built-in thermostat will turn itself on/off within +/- 1degree F according to the desired set temperature.

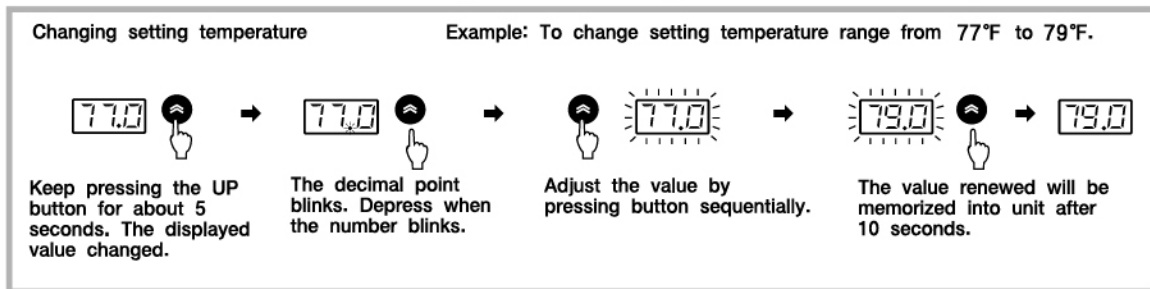

### \* Error representation

The thermostat has self-diagnostic function, so the letters below will be appeared on display if error occurs.

	<b>HI</b> Indicating that the temperature being raised above the specified range. Over-temperature.
	<b>LO</b> Indicating that the temperature lowered below the specified range. Under-temperature.
	<b>Er1</b> Indicating that there is an error occurred in the thermostat itself.

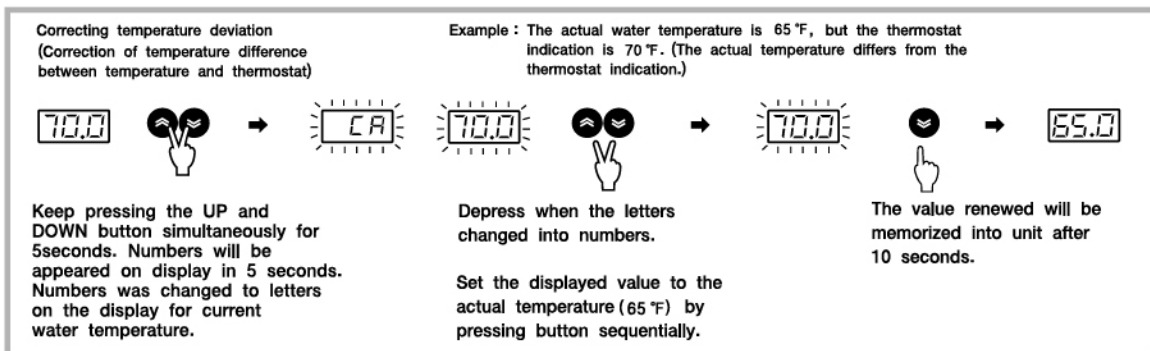

---

## 6. MAINTENANCE

### WARNING

Carry out maintenance operations with the cooler turned off and disconnected from the mains.

#### 6.1 Operations To Be Carried Out Every 6 Months

- **Cleaning of the condenser**

Take off the suction grille and clean the ribbed condenser with a vacuum cleaner or jet of air.

- **Cleaning of the heat exchanger**

To eliminate deposits of impurities, bacteria or metabolic products not captured by the filter, periodic cleaning of the heat exchanger should be carried out, using clean water which should be made to circulate in the opposite direction to the flow when operating.

Table 1  
Cooler Specifications

AQUARIUM CAPACITY	AMBIENT TEMPERATURE RANGE	FLOW RATE	WEIGHT	INLET/OUTLET
Up to 130 Gallons	50–95 Fahrenheit	240 GPH	44 LBS	3/4",5/8",1/2"

MODEL	POWER SUPPLY	COMPRESSOR	REFRIGERANT TYPE
DBA-075	115 VOLT/60Hz	1/10HP	Ozone Friendly/R-134a



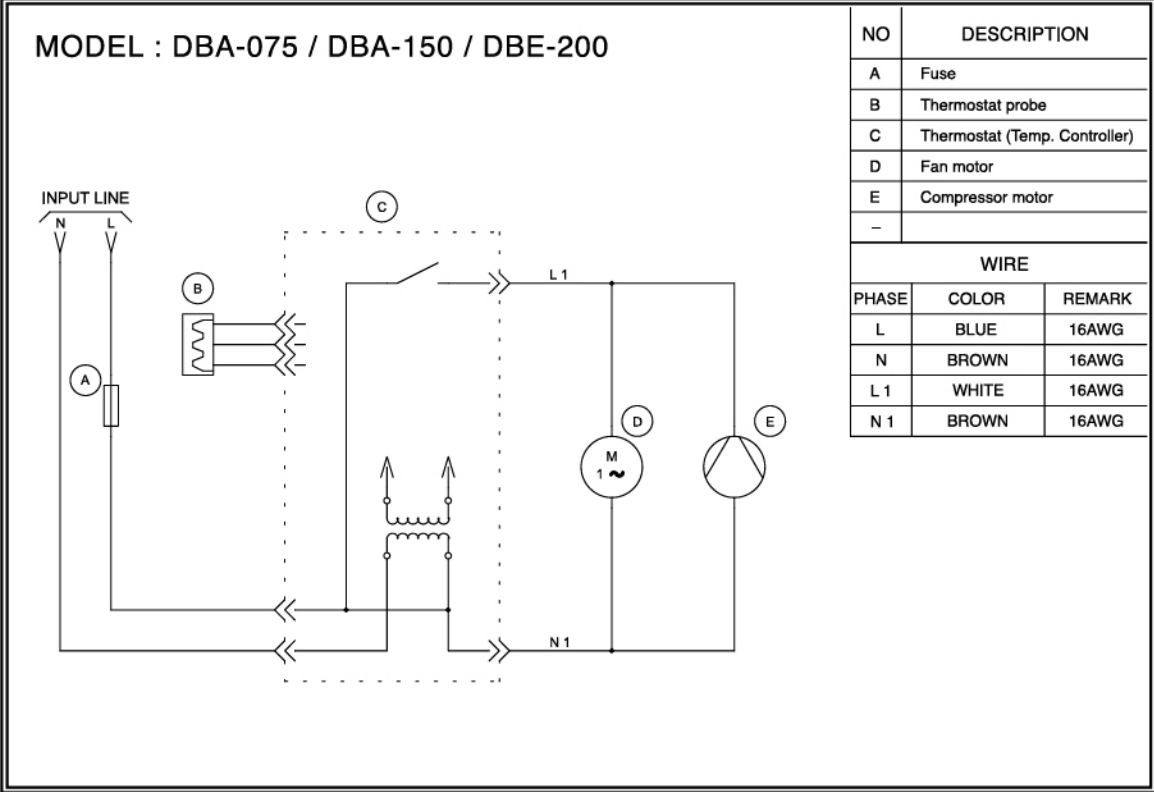
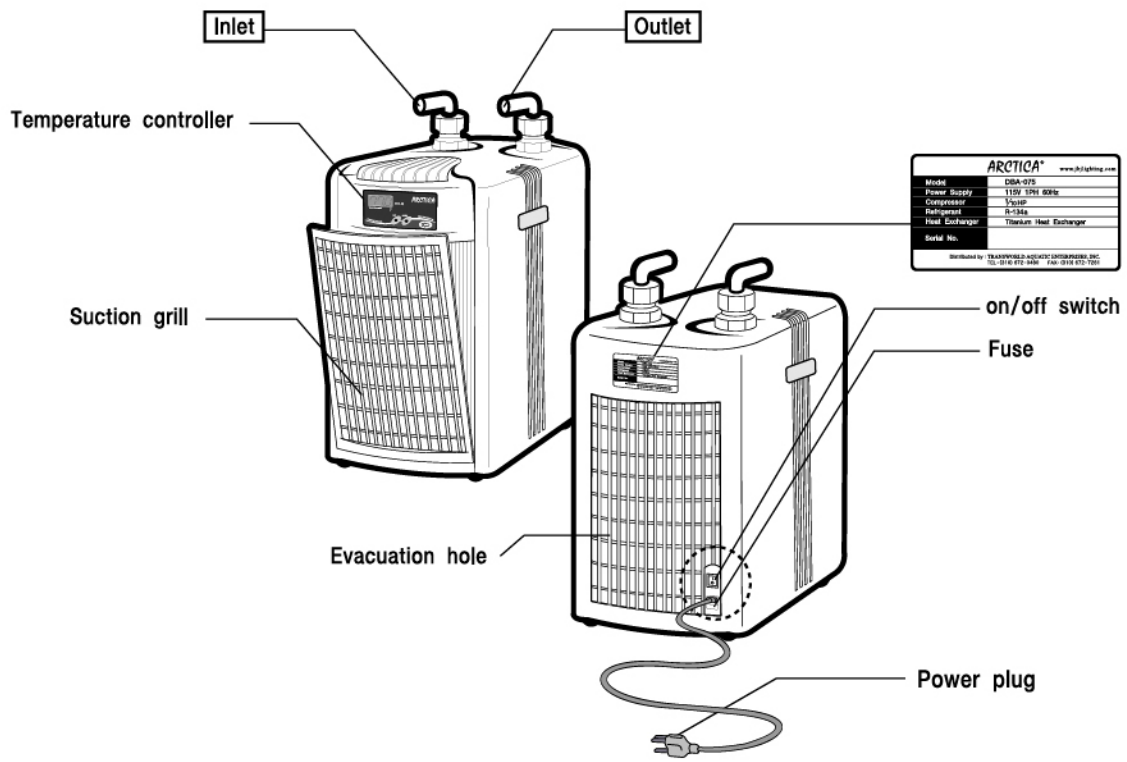

Figure 1  
Electrical Diagram



● **Temperature controller**

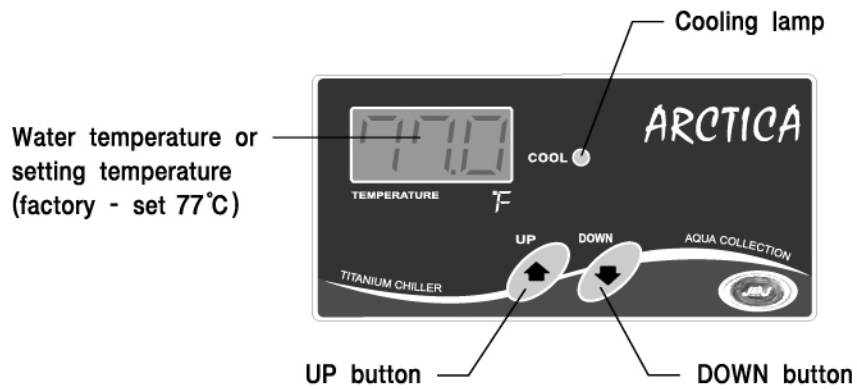

Figure 2  
 Part Name for Cooler

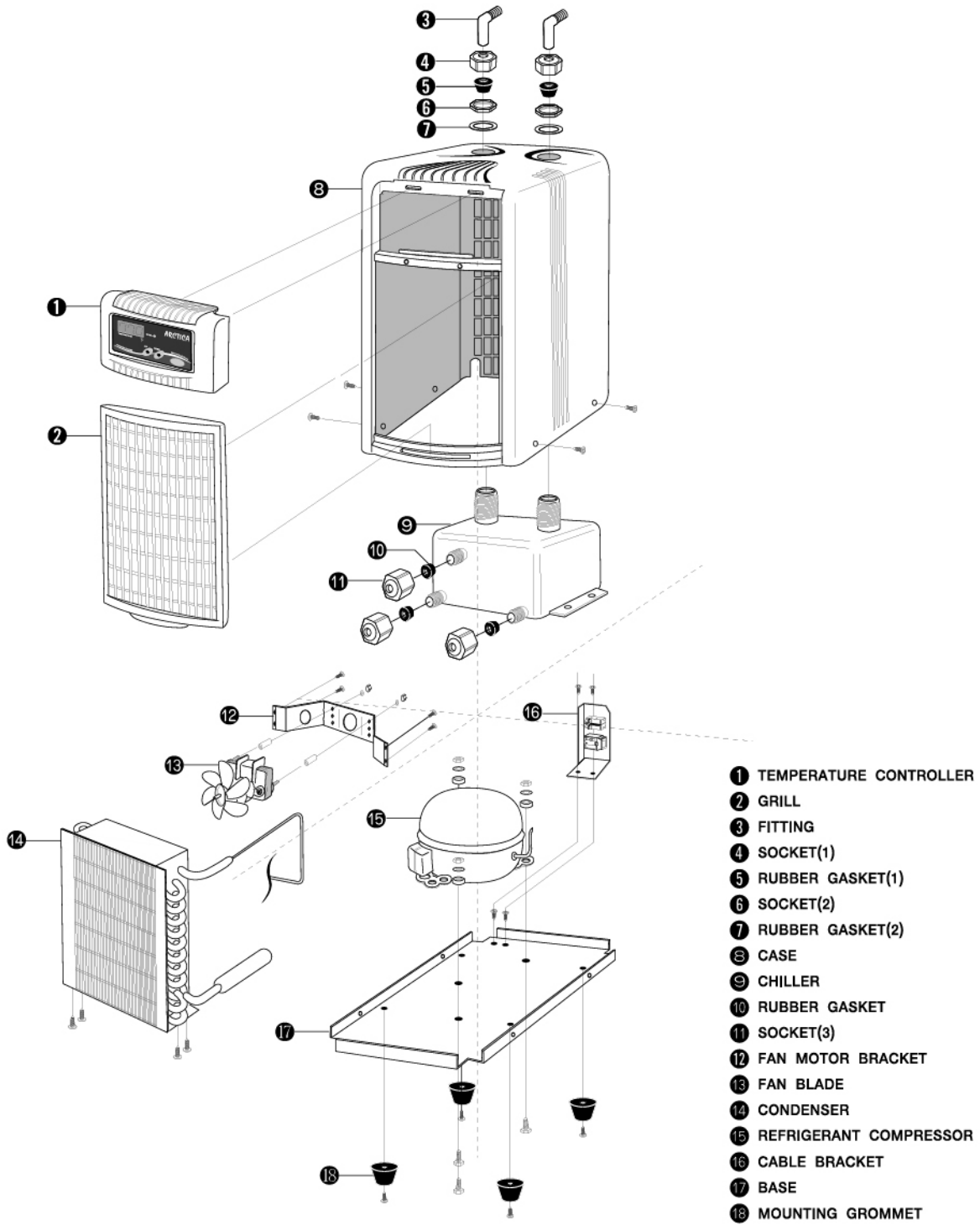

Figure 3  
 Exploded View and Part List

Distributed by  
**TRANSWORLD AQUATIC ENTERPRISES, INC.**  
TEL: (310)672-0480      FAX: (310)672-7261

**www.jbjlighting.com**